

Frontplattenausschnitt
panel cut out

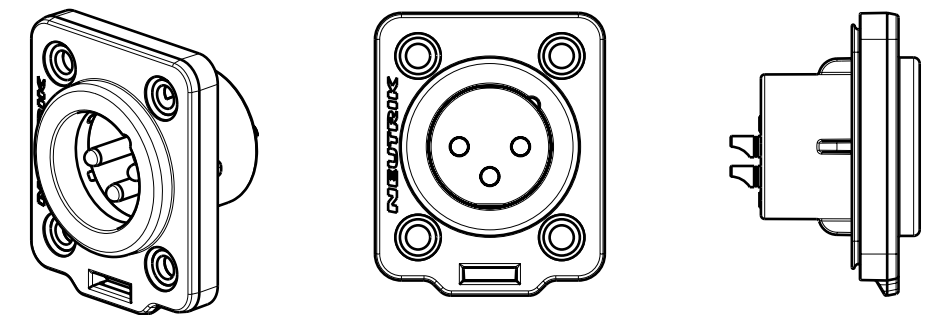
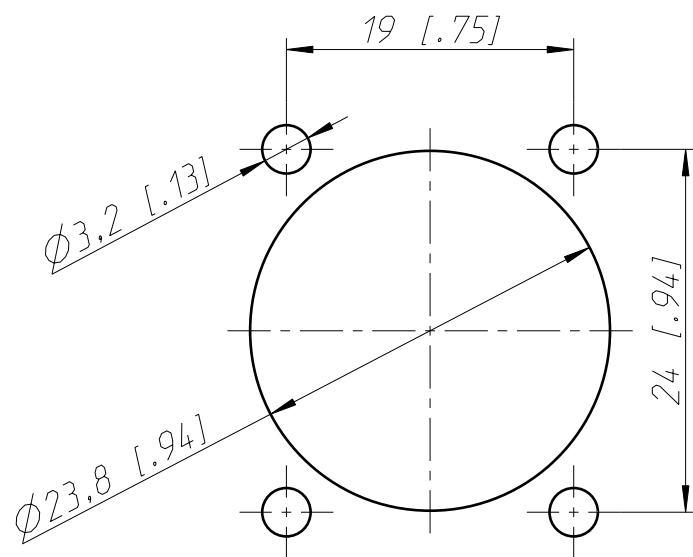

1:1

Refer to protection notice ISO 16016.	Scale 2:1 (A3)	Drawn	Date 01.03.18	Name jutz b
		Modified	28.06.19	jutz b
Name NC3MDX-TOP	Change-No. -	Sheet-No.	1 / 1	Index -
		Replacement for: Drawing-No. ST-NC3MDX-TOP		
NEUTRIK				